

## **Ratchets and Accessories**



**Strength and Reliability**

**A Level of Confidence**

AmPro offers a variety of state-of-the-art ratchet models, which prevents damage from dust and moisture. All ratchets are professional quality made of Chrome Vanadium steel. Quick-release ratchets release sockets with a smooth one-handed operation.



### Stubby Ratchets

**New**

- 72-tooth for 5-degree increment gear action
- Contoured cushion grip handle for added comfort

Model	Size	Length(mm)	Weight(g)
<b>T29850</b>	1/4"	110	100
<b>T29851</b>	3/8"	135	226
<b>T29852</b>	1/2"	170	442

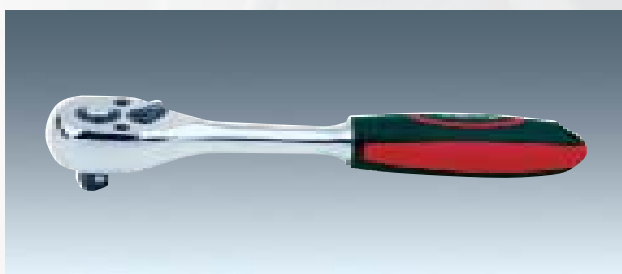

### Standard Ratchets

**New**

- 72-tooth for 5-degree increment gear action
- One-hand reverse direction lever
- Contoured cushion grip handle for added comfort

Model	Size	Length(mm)	Weight(g)
<b>T29818</b>	1/4"	137	125
<b>T29819</b>	3/8"	197	270
<b>T29820</b>	1/2"	260	570

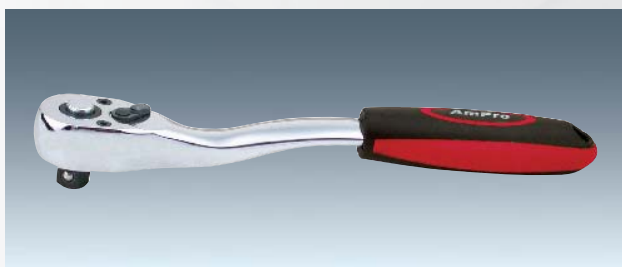

### Offset Ratchets

**New**

- 72-tooth for 5-degree increment gear action
- Contoured cushion grip handle for added comfort
- Offset design for easier access in tight spaces

Model	Size	Length(mm)	Weight(g)
<b>T29860</b>	1/4"	145	132
<b>T29861</b>	3/8"	205	302
<b>T29862</b>	1/2"	255	587

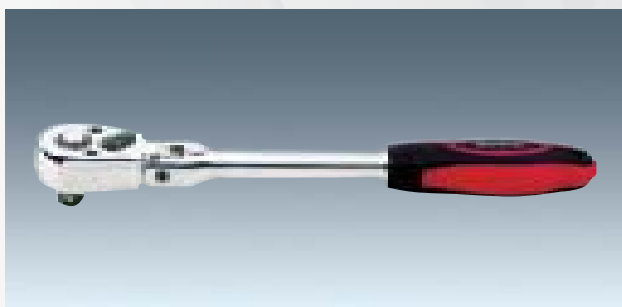

### "Safety Lock" Flex Head Ratchets

**New**

- 72-tooth for 5-degree increment gear action
- Flexible "safety lock" head design
- Contoured cushion grip handle for added comfort

Model	Size	Length(mm)	Weight(g)
<b>T29856</b>	1/4"	150	135
<b>T29857</b>	3/8"	240	395
<b>T29858</b>	1/2"	283	686



### 1/4" Dr. Mini Ratchet and Bit Driver

**New**

- 72-tooth for 5-degree increment gear action
- 2-in-1 head design for both sockets and bits
- Palm size tool to work in confined areas

Model	Size	Length(mm)	Weight(g)
<b>T29871</b>	1/4"	110	102



### Dual-Drive Stubby Ratchets

**New**

- 2-in-1 combo drive design
- 72-tooth for 5-degree increment gear action
- Stubby size allows access in confined areas

Model	Size	Length(mm)	Weight(g)
<b>T29872</b>	1/4" & 3/8"	136	260
<b>T29876</b>	3/8" & 1/2"	136	277
<b>T29875</b> (Jumbo Size)	3/8" & 1/2"	170	469



### Dual-Drive "Safety Lock" Flex Stubby Ratchets

**New**

- 72-tooth for 5-degree increment gear action
- Contoured cushion grip handle for added comfort
- Flex head swings 180-degree for added versatility

Model	Size	Length(mm)	Weight(g)
<b>T29873</b>	1/4" & 3/8"	154	310
<b>T29874</b>	3/8" & 1/2"	154	327



### Dual-Drive Standard Ratchets

**New**

- 72-tooth for 5-degree increment gear action
- Contoured cushion grip handle

Model	Size	Length(mm)	Weight(g)
<b>T29848</b>	1/4" & 3/8"	197	291
<b>T29849</b>	3/8" & 1/2"	278	583



### Dual-Drive "Safety Lock" Flex Head Ratchets

**New**

- 72-tooth for 5-degree increment gear action
- Contoured cushion grip handle

Model	Size	Length(mm)	Weight(g)
<b>T29845</b>	1/4" & 3/8"	245	376
<b>T29846</b>	3/8" & 1/2"	245	396

(Jumbo)

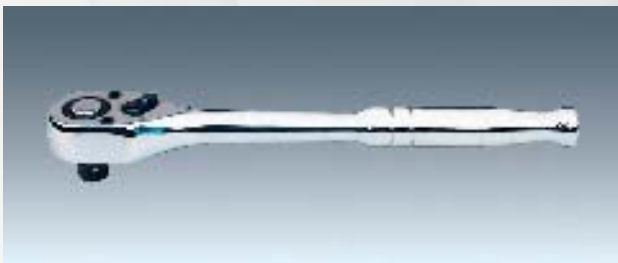

### "Metal Grip" Ratchets

- One-hand reverse direction level
- 36-tooth for 10-degree increment gear action
- Shape allows better access in tight areas

Model	Size	Length(mm)	Weight(g)
<b>T29824</b>	1/4"	127	127
<b>T29825</b>	3/8"	178	310
<b>T29826</b>	1/2"	258	640

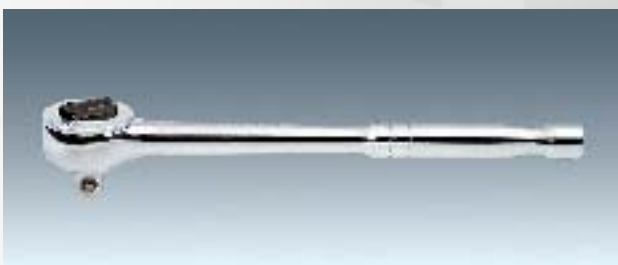

### Regular Ratchets

- Up to 45-tooth ratcheting action
- Chrome plated finish for corrosion protection
- Built-in knurled speeder for finger adjustment

Model	Size	Length(mm)	Weight(g)
<b>T29800</b>	1/4"	140	150
<b>T29801</b>	3/8"	200	364
<b>T29802</b>	1/2"	250	604





### Stubby 3/8" Dr. Ratchets

- 72-tooth for 5-degree increment gear action
- Built-in knurled speeder for finger adjustment
- Ergonomic, contoured grip handle

Model	Size	Length(mm)	Weight(g)
<b>T49840</b>	3/8"	128	205



### Stubby Ratchet

- 72-tooth for 5-degree increment gear action
- Built-in knurled speeder for finger adjustment
- Palm size tool to work in confined areas

Model	Size	Length(mm)	Weight(g)
<b>T49870</b>	1/4"	110	110



### Offset Ratchets

- 72-tooth for 5-degree increment gear action
- Built-in knurled speeder for finger adjustment
- Offset design for easier access in tight spaces

Model	Size	Length(mm)	Weight(g)
<b>T49833</b>	1/4"	150	145
<b>T49834</b>	3/8"	210	325
<b>T49835</b>	1/2"	250	490



### High Torque Ratchets

**New**

- 72-tooth for 5-degree increment gear action
- Built-in knurled speeder for finger adjustment
- Ergonomic, contoured grip handle

Model	Size	Length(mm)	Weight(g)
<b>T29836</b>	1/4"	145	115
<b>T29837</b>	3/8"	195	215
<b>T29838</b>	1/2"	250	480



### "Box Style" Ratchets

- Quick-Release model
- One hand, reverse direction lever
- Cushioned, ribbed handle for added grip and comfort

Model	Size	Length(mm)	Weight(g)
<b>T29809</b>	1/4"	150	96
<b>T29810</b>	3/8"	202	224
<b>T29811</b>	1/2"	270	504

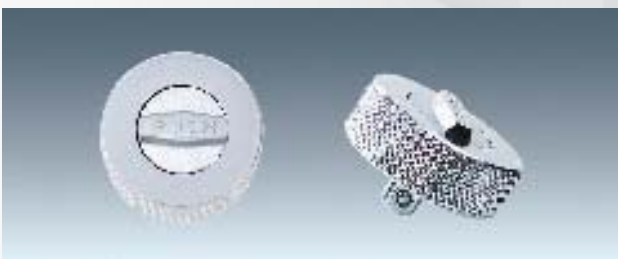

### Finger Ratchets

**New**

- Palm control design
- Works easy with hex screws, nuts and bolts

Model	Size	Weight(g)
<b>T29853</b>	1/4"	127
<b>T29854</b>	3/8"	263

**T29855** 2pc Finger Ratchet Set (1/4" Dr., 3/8" Dr.)

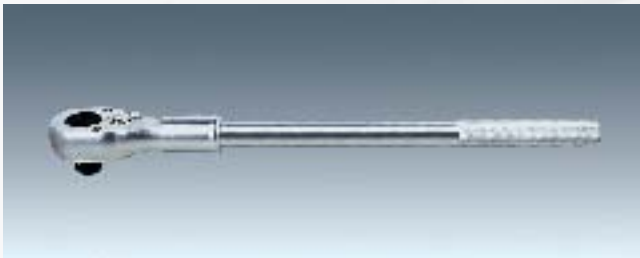

### 3/4" Dr. Heavy Duty Ratchet

- Chrome Vanadium steel
- Nickel and Chrome finish
- Heavy duty "twin-pawl" design for added strength

Model	Size	Length(mm)	Weight(g)
<b>T29880</b>	3/4"	500	2430



### 1" Dr. Super Duty Ratchet

- Chrome Vanadium steel
- Nickel and Chrome finish
- Heavy duty, "twin-pawl" design for added strength

Model	Size	Length(mm)	Weight(g)
<b>T29890</b>	1"	650	4040



### Heavy Duty Socket Holder Rails

- Heavy duty metal rail
- Easy-to-carry, pro style handle
- 14pc socket clips

Model	Size	Length(mm)	Weight(g)
<b>T21100</b>	1/4"	175	155
<b>T21101</b>	3/8"	175	165
<b>T21102</b>	1/2"	175	185



### **T20720** 3-in-1 Flex T-Handle

**New**

A dynamic multi-purpose tool

- Foldable handle for easy carry and storage
- 3 drives in one handle - 1/4", 3/8", 1/2"
- Strong head design for professional use
- Loosens stubborn nuts and bolts
- Chrome Vanadium steel

### **T20721** 3-in-1 Adjustable Flex T-Handle

**New**

- 3/8" Dr. - Extends 10" - 16"

### **T20722** 3-in-1 Adjustable Flex T-Handle

**New**

- 1/2" Dr. - Extends 12" - 20"

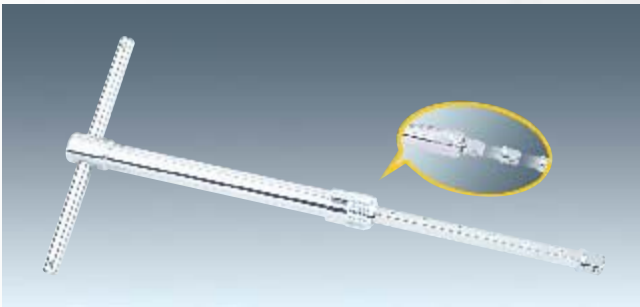
**T20723 Adjustable T-Handle**

- 3/8" Dr. - Extends 10" - 16"

**New**
**T20725 Adjustable T-Handle**

- 1/2" Dr. - Extends 12" - 20"

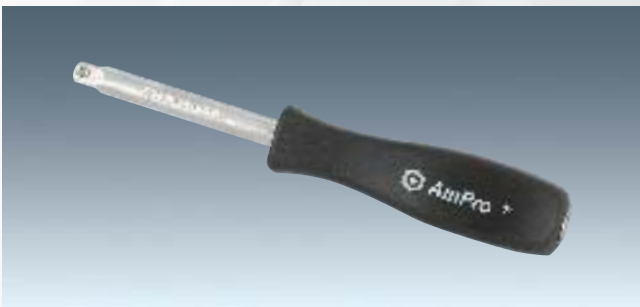
**T32580 1/4" Dr. x 6" Spinner Handle**

- Chrome Vanadium steel
- Quickly tightens and loosens fasteners
- Features 1/4" Dr. "F" Square Drive at end of handle

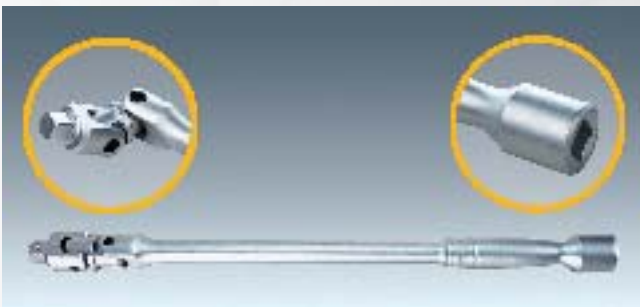
**1/2" Dr. Universal Flex / Extension Handle**

- Heavy duty double universal head design
- Universal joint and 1/2" Dr. extension bar all-in-one
- Chrome Vanadium steel

Model	Size	Length(mm)	Weight(g)
<b>T20724</b>	1/2"	435	985

**1/2" Dr. x 24" Heavy Duty Breaker Bar**

- Strong head design for professional use
- Chrome Molybdenum steel

Model	Size	Length(mm)	Weight(g)
<b>T20727</b>	1/2"	610	1372

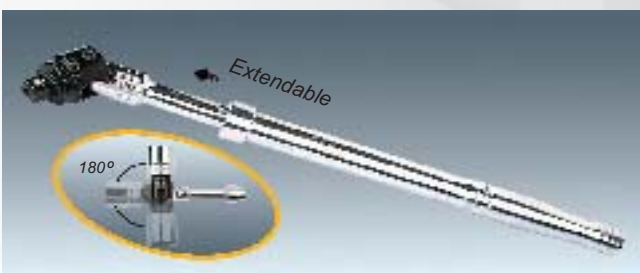
**1/2" Dr. Extendable Breaker Bar (15"~24")**

- Extendable handle for greater leverage and easy carry
- Chrome Vanadium steel

Mode	Size	Length(mm)	Weight(g)
<b>T20726</b>	1/2"	380 - 600	1235





### Flex Handles

**New**

- Chrome Vanadium steel, sand blasted finish
- Hardened, tempered and chrome plated
- Spring loaded ball bearing construction

Mode	Size	Length	Weight(g)
<b>T20700</b>	1/4"	140mm, 5-1/2"	116
<b>T20705</b>	3/8"	200mm, 8"	289
<b>T20706</b>	3/8"	250mm, 10"	310
<b>T20714</b>	1/2"	380mm, 15"	810
<b>T20716</b>	1/2"	450mm, 18"	830
<b>T20732</b>	3/4"	475mm, 19"	1850
<b>T20736</b>	1"	650mm, 26"	3700

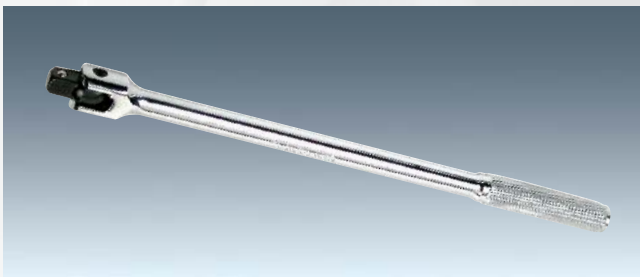

### Flex Handles

- Chrome Vanadium steel, fully polished finish
- Hardened, tempered and chrome plated
- Spring loaded ball bearing construction

Mode	Size	Length(mm)	Weight(g)
<b>T20704</b>	3/8"	200mm, 8"	295
<b>T20713</b>	1/2"	380mm, 15"	725

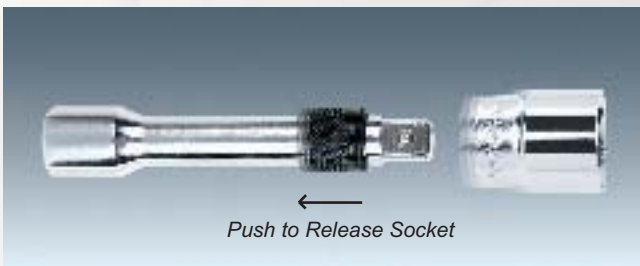

### Quick-Release Extension Bars

**New**

Model	Size	Length	Weight(g)
<b>T11363</b>	3/8"	75mm, 3"	81
<b>T11364</b>	3/8"	150mm, 6"	147
<b>T11365</b>	3/8"	250mm, 10"	403

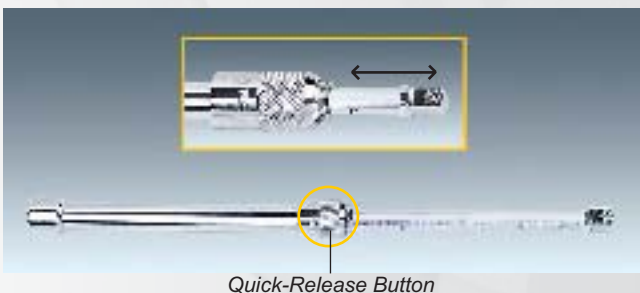

### Adjustable Extension Bars

**New**

Model	Size	Range	Weight(g)
<b>T11370</b>	3/8"	10" ~ 16"	410
<b>T11371</b>	1/2"	12" ~ 20"	720



### Extension Bars

Model	Size	Length	Weight(g)
<b>T11400</b>	1/4"	2"	23
<b>T11402</b>	1/4"	6"	63
<b>T11415</b>	3/8"	3"	74
<b>T11416</b>	3/8"	6"	139
<b>T11418</b>	3/8"	10"	228
<b>T11425</b>	1/2"	5"	194
<b>T11426</b>	1/2"	10"	381

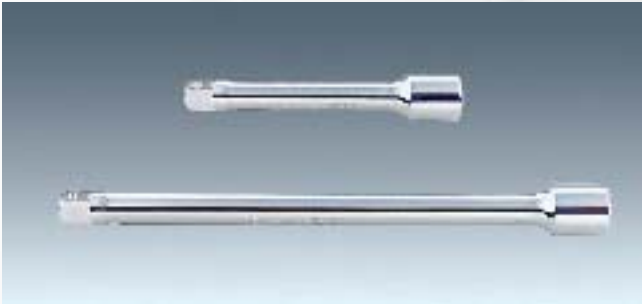

### Extension Bars

Model	Size	Length	Weight(g)
<b>T11300</b>	1/4"	56mm, 2"	25
<b>T11301</b>	1/4"	75mm, 3"	34
<b>T11302</b>	1/4"	150mm, 6"	67
<b>T11310</b>	3/8"	75mm, 3"	75
<b>T11313</b>	3/8"	150mm, 6"	145
<b>T11320</b>	1/2"	75mm, 3"	140
<b>T11322</b>	1/2"	125mm, 5"	225
<b>T11324</b>	1/2"	250mm, 10"	430
<b>T11331</b>	3/4"	100mm, 4"	400
<b>T11332</b>	3/4"	200mm, 8"	700
<b>T11334</b>	3/4"	400mm, 16"	1400
<b>T11336</b>	1"	200mm, 8"	1350
<b>T11338</b>	1"	400mm, 16"	2480



### Extension Bars with Magnet

**New**

Model	Size	Length(mm)	Weight(g)
<b>T11354</b>	3/8"	150 6"	160
<b>T11355</b>	3/8"	250 10"	260
<b>T11357</b>	1/2"	125 5"	250
<b>T11358</b>	1/2"	250 10"	460

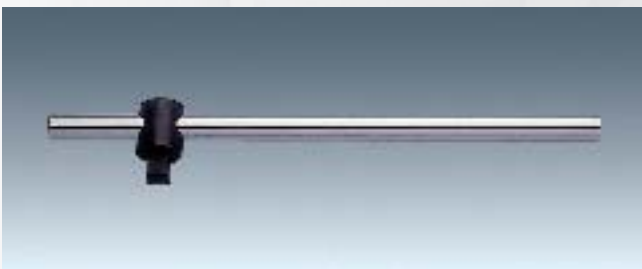

### Sliding T-Handle

Model	Size	Length(mm)	Weight(g)
<b>T20741</b>	1/4"	115	42
<b>T20742</b>	3/8"	200	147
<b>T20744</b>	1/2"	250	360
<b>T20745</b>	1/2"	300	435
<b>T20747</b>	3/4"	450	1380
<b>T20748</b>	3/4"	500	1500
<b>T20749</b>	1"	560	3340

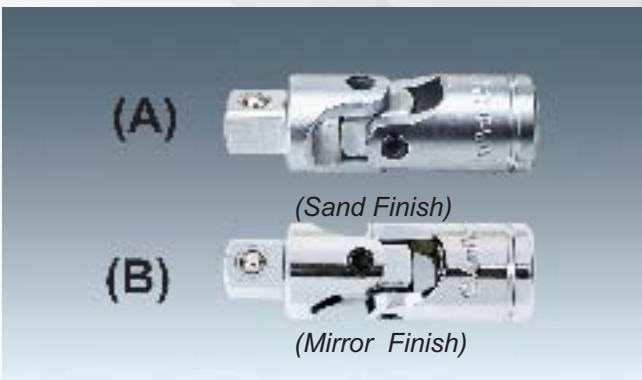

### Universal Joints

- Adds flexibility to use sockets at various angles
- Chrome Vanadium steel

	Model	Size	Length(mm)	Weight(g)
A	<b>T33300</b>	1/4"	40	27
	<b>T33302</b>	3/8"	55	58
	<b>T33304</b>	1/2"	78	160
	<b>T33306</b>	3/4"	109	590
	<b>T33308</b>	1"	140	1155
B	<b>T33301</b>	1/4"	40	27
	<b>T33303</b>	3/8"	55	58
	<b>T33305</b>	1/2"	78	160



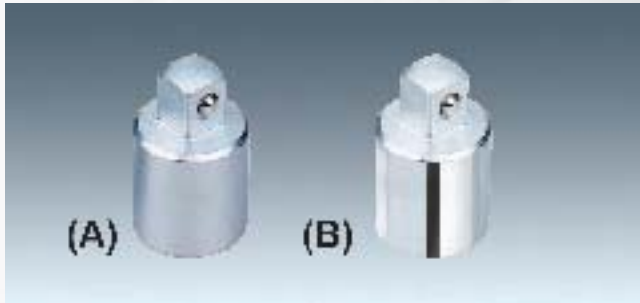

### Socket Adaptors

	Model	Size	Length(mm)	Weight(g)
<b>A</b>	<b>T33312</b>	3/8" F x 1/4" M	27	31
	<b>T33313</b>	3/8" F x 1/2" M	35	47
	<b>T33314</b>	1/2" F x 3/8" M	34	50
	<b>T33315</b>	1/2" F x 3/4" M	50	120
	<b>T33316</b>	3/4" F x 1/2" M	54	200
	<b>T33317</b>	3/4" F x 1" M	62	380
	<b>T33318</b>	1" F x 3/4" M	70	500
<b>B</b>	<b>T33331</b>	1/4" F x 3/8" M	25	24
	<b>T33332</b>	3/8" F x 1/4" M	27	31
	<b>T33333</b>	3/8" F x 1/2" M	35	47
	<b>T33334</b>	1/2" F x 3/8" M	34	50



### Spark Plug Sockets

Model	Size	Length(mm)	Weight(g)
<b>T33320</b>	3/8" Dr. x 16mm	65	94
<b>T33322</b>	3/8" Dr. x 21mm	65	148
<b>T33323</b>	1/2" Dr. x 16mm	65	94
<b>T33325</b>	1/2" Dr. x 21mm	65	148
<b>T33340</b>	3/8" Dr. x 5/8"	65	94
<b>T33341</b>	3/8" Dr. x 13/16"	65	148
<b>T33342</b>	1/2" Dr. x 5/8"	65	94
<b>T33343</b>	1/2" Dr. x 13/16"	65	148



### Spark Plug Sockets with Magnet

Model	Size	Length(mm)	Weight(g)
<b>T33390</b>	3/8" Dr. x 16mm	67	94
<b>T33391</b>	3/8" Dr. x 21mm	67	148
<b>T33392</b>	1/2" Dr. x 16mm	67	94
<b>T33393</b>	1/2" Dr. x 21mm	67	148
<b>T33394</b>	3/8" Dr. x 5/8"	67	94
<b>T33395</b>	3/8" Dr. x 13/16"	67	148
<b>T33396</b>	1/2" Dr. x 5/8"	67	94
<b>T33397</b>	1/2" Dr. x 13/16"	67	148



### Extended Flex Spark Plug Socket

**New**

Model	Size	Length(mm)	Weight(g)
<b>T33338</b>	3/8" Dr. x 5/8"	342	366
<b>T33339</b>	3/8" Dr. x 13/16"	342	412